

# Hydrogen Sulfide Monitor Instruction Manual



# CONTENTS

<b>1.Introduction</b>	(01)
<b>2.Scope of application</b>	(01)
<b>3.Safety instruction</b>	(01)
<b>4.International safety knowledge</b>	(02)
<b>5.Explosion protection precautions</b>	(02)
<b>6.Name of parts</b>	(03)
<b>7.Features</b>	(04)
<b>8.Operation manual</b>	(04)
○ Main Menu Interface	(04)
○ Real-time Measurement Interface	(05)
○ Record Checking Interface	(06)
○ Alarm Setting Interface	(10)
○ System settings interface	(11)
<b>9.Calibration Interface (ONLY FOR PROFESSIONAL)</b>	(11)
○ Sensor Calibration Interface	(11)
○ Three Sensor Calibration Methods	(12)
<b>10.Specifications</b>	(14)
<b>11.Charging function description</b>	(15)
<b>12.Warnings and Precautions</b>	(15)
<b>13.Product accessories list</b>	(17)

## 1. Introduction

Hydrogen Sulfide Monitor adopts high-quality gas sensors, which displays safety and reliability with accurate measurement and stable performance. It has excellent sensitivity and repeatability, easy to use and maintain, and meets the requirements by safety monitoring in industrial site for high reliability of the equipment. The shell is made of high-strength engineering plastics and compound non-slip rubber, dust and explosion-proof, with high strength and smooth handfeel.

This instrument conforms with the following procedures and calibration standards:

Gb3836.1—2010 Explosive Atmospheres Part 1: General Requirements for Equipment.

GB3836.4—2010 Explosive Atmospheres Part 4: Equipment with Intrinsically Safe "I" Protection.

JJG695-2003 Verification Procedure for Hydrogen Sulfide Gas Detector

## 2. Scope of application

Hydrogen Sulfide Monitor is widely used in petroleum, chemical, environmental protection, metallurgy, refining, gas transmission and distribution, biochemical medicine, agricultural research, etc.

## 3. Safety instruction

For your safety, please read this manual before operation.

 : This operation may induce physical hazard to users.

Please be careful.

- : This operation may cause damage to the instrument.  
Please be careful.

 Warning!

If there is explode accident happening:

- Cut off all the potential gas resource.
- Keep the rescuing area ventilated and no potential combustible gas existing.
- Switch off all the power connection.
- Evacuate all the people in the area.
- Report to the authorities immediately.

In daily work, please keep the work environment ventilated, for good ventilation can ensure that combustible gas will not accumulate.

## 4. International safety knowledge

 This operation must refer to instruction. Please be careful.

 Complying with eu standard.

Explosion-proof sign: Ex ib IIB T3 Gb.

## 5. Explosion protection precautions

 Warning!

1. Charging in the off state is unable to turn on the gas detection alarm for detection. Please do not charge the gas detection alarm at the inspection site to avoid fire or explosion caused by the spark generated by the plug-in charger.
2. Please do not disassemble, replace or replace the sensor in an explosive atmosphere, and do not use peripheral plug-in equipment that is not certified for explosion-proof.

## 6.Name of parts

①. Alligator clips on the back.

②. Transparent window for alarm indicator.

③. LCD display.

④. DC adaptor socket.

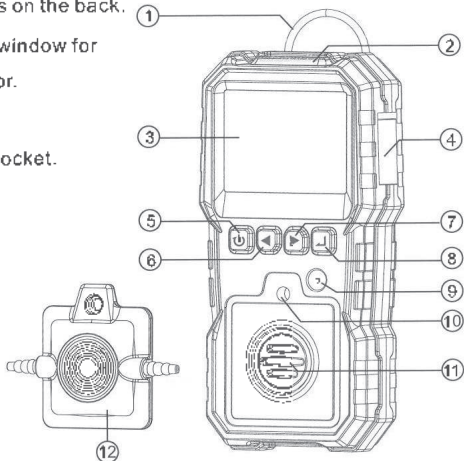

Figure 1

⑤.  Return button: long press on/off button, short press to return.

⑥.  Left button: left forward, upward, decrease.

⑦.  Right button: right forward, downward, increase.

⑧.  Confirm button: confirmation.

⑨. Buzzer alarm hole.

⑩. This hole is used to connect the calibration cover when calibrating.

⑪. Gas sensing hole.

⑫. Gas calibration cover.

## 7.Features

- Color-screen display, user-friendly interface.
- Bilingual choices:Chinese/English.
- Three alarm forms:sound/light/vibration .
- Data recording and review function, continuously record 120,000 data.
- Charging function.

## 8.Operation manual

### ○ Main Menu Interface (Such as Figure 2)

1. Long press on/off button (back button) for about 2 seconds.  
After powering on, the instrument enters into the countdown interface (for the sensor takes about 20 seconds to stabilize). After the countdown is over, the main menu screen will appear, as shown in picture 2.
2. The current date and time are displayed on the upper left corner.If the time is incorrect, enter the settings interface to set.
3. The battery level is displayed on the upper right corner. When the remaining power is low, the battery indicator will turn red. When the power level is detected to be too low, the instrument will start 10s countdown for automatic shutdown.

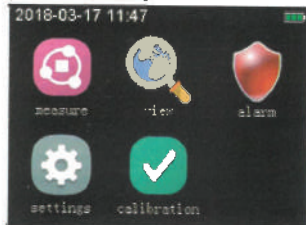

Main Menu Interface Display(Figure 2)

The countdown second will be displayed on the left side of the battery indicator. After the countdown is over, the instrument will automatically shut down.

4. There are five icon options in the main menu, namely, real-time measurement, checking record, alarm setting, system setting, and calibration;

5. Functions of Buttons:

1) Back button (⏪): When the icon is selected, touch the icon and it will turn unselected, touch it again to go back to the first icon (unselected).

2) Left/right button (◀) / (▶): If an icon is not selected, touch the icon and it will become selected. Touch it again to select the next icon by pressing left/ right button.





3) Confirm button (⏹): If an icon is not selected, touch it once and the icon will turn selected; when the icon is selected, press confirm button to enter the corresponding interface of the icon.

#### ○ Real-time Measurement Interface (Such as Figure 3)

1. This interface only displays Real-time measurement values; the left side shows the maximum minimum, and average value, where the average value is the value measured in the last 4 minutes; the right side shows the high and low alarm values, and the middle shows real-time values.



Real-time Measurement interface  
(Figure 3)

2. When checking concentration, if the concentration value is greater than the low alarm value, the instrument will trigger low alarm state. If the concentration is greater than the high alarm value, the instrument will trigger high alarm state.
3. In alarm state, Danger icon shows up; otherwise, Safety icon is displayed.
4. In the alarm state, if the alarm is triggered, an alarm will be issued and the alarm will be issued when the alarm is high. The alarm in high alarm state shows more urgency and faster frequency than that of low alarm state.
5. The alarm has three forms, light flashing alarm, sound alarm and vibration alarm, which can be turned on/off in the alarm setting.
6. The lower left corner of the screen shows the lower limit of the range, the lower right corner shows the upper limit of the range, the lowermost triangle indicates the color of realtime value.
7. Function of buttons:
  - 1) Back button  : back to main menu interface.
  - 2) Left/right button  /  : No use
  - 3) Confirm button  : No use.

#### ○ Record Checking Interface(Such as Figure 4~Figure 9)

1. After entering record checking interface, as shown in Figure 4, the screen shows the number of each record, start time of record, number of record groups, record interval (seconds) from left to right ; each record can store 1019 pieces of data, and a total of 125 groups of records can be stored.

When the stored data is full, "FULL" will appear at the top of screen. The bottom shows the selected page number and total page number; which is page selection interface. Press "⏪" button to return to main menu, and press "◀ / ▶" button to choose previous or next page. After selecting page number, press "⏩" button to choose one record and enter into record selection interface, as shown in Figure 5.

2018-03-13 17:06

NO.	start record time	total	interval
1	2018.01.25 17:56:40	91	1
2	2018.01.25 17:58:37	203	1
3	2018.01.25 18:04:08	3	1
4	2018.01.25 18:04:29	1	1
5	2018.01.25 18:22:23	1019	1
6	2018.01.25 18:40:47	1019	1
7	2018.01.25 18:59:20	1019	1
8	2018.01.25 19:17:54	449	1

1 / 10 next ▶

Page selection interface (Figure 4)

2. In record selection interface shown in Figure 5, press "⏪" button to return to page selection interface. Press "◀" / "▶" button to choose previous or next page. Press "⏩" button to check, delete, and choose which data to be delete, as shown in Figure 6.

2018-03-13 17:10

NO.	start record time	total	interval
33	2018.01.27 11:51:44	1019	1
34	2018.01.27 12:11:42	1019	1
35	2018.01.27 12:32:05	1019	1
36	2018.01.27 12:52:18	1019	1
37	2018.01.27 13:12:24	1019	1
38	2018.01.27 13:32:53	1019	1
39	2018.01.27 13:53:05	997	1
40	2018.01.29 09:59:25	151	1

◀previous 5 / 10 next ▶

Record Checking Interface (Figure 5)

3. In record selection interface shown in Figure 6, press "⏪" button to return to record selection state Press "⏩"/"⏪" button to check, delete, and choose which data to be deleted. Press "⏴" button to enter into interface for checking (Figure 7), deleting (Figure 8) and selected deletion (Figure 9).

2018-03-13 17:25 64

NO.	start record time	total	interval
33	2018.01.27 11:51:44	1019	1
34	2018.01.27 12:11:42	1019	1
35	2018.01.27 12:32:05	1019	1
36	2018.01.27 12:52:16	1019	1
37	2018.01.27 13:12:24	1019	1
38	2018.01.27 13:32:53	1019	1
39	2018.01.27 13:53:05	997	1
40	2018.01.29 09:59:25	151	1

⏪ view delete select del ⏩

Checking delete interface(Figure 6)

4. The interface shown in Figure. 7 is a reviewing recorded data interface, and the box above shows the number of recorded data in different numerical ranges. For example, the green bar graph with 64 in the figure indicates that 64 values in the recorded data are between 54.7 and 60.3. The maximum, minimum and average value of recorded data are displayed on the right side. the concentration value 45.2 displayed in the middle is the value of the data point pointed out by red line; the lower right corner reads 1/351, where 1 is the data point number, and 351 is the group number of the recorded data;  is an icon back to the start point, select the icon and press the "⏴" button, the data point number will return to 1, and the red line goes

back to the beginning; ▶ is an icon for starting, after selecting it, the recorded data will automatically start reviewing, and the icon will turn into ||, after selecting it, the automatic review will stop, the icon will turn into ▶; < is an icon for moving leftwards, after selecting it and confirming, the red line will move to the left; > is an icon for moving rightwards, after selecting it, the red line will move to the right; << is an icon for fast moving leftwards; >> is an icon for fast moving rightwards.

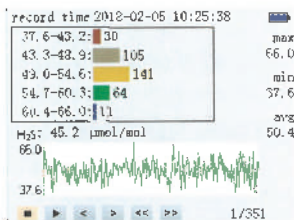

Record data playback interface (Figure 7)

5. Figure 8 shows deletion interface. After selecting "Yes" and confirm, the recorded data will be deleted.

2018-03-14 10:54

No.	start record time	total	interval
57	2018.03.13 10:27:12	67	1
58	2018.03.13 10:52:18	14	1
59	Are you sure delete?		
60	NO YES		
61			
62	2018.03.13 16:11:03	170	1
63	2018.03.13 16:20:54	21	1
64	2018.03.13 16:22:01	732	1

◀ view delete select del ▶

Deletion Interface (Figure 8)

6. Figure 9 shows selected deletion interface. Pressing “◀”/“▶” button and “⏏” button to input the serial number to be deleted, select “OK” and press “⏏” button. After that, the data within the range of serial number will be deleted.

2018-03-14 10:58

NO.	start	record time	total	interval
65	2018.03.13	17:06:04	1019	1
66	2018.03.13	17:23:20	511	1
67	select the num to delete			
68	0000 ~ 0000 enter			
69				
70	2018.03.14	05:10:00	1019	1
71	2018.03.14	09:36:16	1019	1
72	2018.03.14	09:54:40	1019	1

◀ view delete select del ▶

Selected Deletion Interface (Figure 9)

### ○ Alarm Setting Interface(Such as Figure 10)

1. The alarm settings for each sensor can be set separately under this interface.
2. There are three alarm modes: light, sound, and vibration, which can be respectively set to be on or off. When the realtime measured value is greater than the set high alarm value or low alarm value, the alarm which is on will be triggered.

2019-03-05 14:51

alarm	light	<input checked="" type="checkbox"/>
H <sub>2</sub> S	sound	<input checked="" type="checkbox"/>
	shock	<input checked="" type="checkbox"/>
	upper	20.0 μmol/mol
	lower	06.0 μmol/mol

Alarm Setting Interface(Figure10)

## ① System settings interface(Such as Figure 11)

1. There are six setting items under the interface: language, date and time, auto storage, auto power off, backlight setting, and reset default.
2. The language can be Chinese or English; date and time can be set as year, month, day, hour, minute; if auto storage is on, the measured data will be automatically saved according to the set recording interval. If not, it will not be stored automatically; if the auto off is on, if there is no button operation within the set shut-down time, it will automatically shut down. If auto off is not on, it will not automatically shut down; in the backlight setting, there are three levels of backlight brightness; restoring factory setting can restore all parameters except for date and time (including calibration parameters) in the instrument to factory state.



System settings interface (Figure 11)

## 9. Calibration Interface (ONLY FOR PROFESSIONAL)

### ① Sensor Calibration Selection Interface (Such as Figure 12)

1. In the interface of Figure 12, the left side is the calibration point option, the right side is the calibration parameter corresponding to each calibration point, and the real-time value, minimum value, maximum value, average value and signal value graph of sensor

signals are displayed in the lower right area; the concentration setting refers to setting the concentration value to be calibrated; calibration AD value refers to the signal value output by the sensor corresponding to the set concentration value; offset adjustment refers to the reading plus or minus the set deviation on the basis of the calibration point; timing calibration means that after the timing calibration is on, the countdown of the set timing starts. When the countdown reaches 0, the measured signal value is automatically stored in the calibration AD value. Manual calibration means that when the manual calibration is on, the realtime signal value is stored in the calibration AD value by pressing "  " button; the value between manual calibration icon and ENTER icon is the real-time measured concentration value.

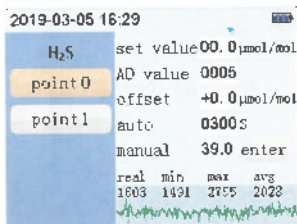

Sensor Calibration Interface (Figure 12)

### ○ Three Sensor Calibration Methods

1. there are three kinds of calibration methods:

1) Input the calibration AD value directly:



a. Set concentration value.

b. Open to calibration gas which has set concentration value;

- c. Wait for the signal curve at the lower right of screen to be stable;
- d. After the signal is stable, input the real-time signal value to calibration AD value.

2) Manual Calibration:

- a. Set concentration value;
- b. Open to the calibration gas which has set the concentration value;
- c. Wait for the signal curve at the lower right of screen to be stable;
- d. After the signal is stable, select manual calibration.

Press "  " button to confirm that the icon will be selected.  
Press "  " button again and the real-time signal value will be added to the calibration AD value.

3) Timing calibration:

- a. Set the concentration value;
- b. Open to the calibration gas with the set concentration value;
- c. Select timing calibration, press "  " button, input the timing, then countdown starts, when the countdown reaches 0, the real-time signal value will be added to the calibration AD value.

4) if the calibration is wrong, you can recalibrate or restore to factory settings in system settings.

2. When calibrating the zero point of carbon monoxide, hydrogen sulfide, and combustible gas, you can increase the calibration AD value by 5-9 to prevent the readings from appearing unrecoverable.

## 10. Specifications

Gas detection	H <sub>2</sub> S
Measuring range	0~100μmol/mol
Resolution	0.1
Accuracy	≦ ±5%FS
Response time (90%)	Less than 30 seconds
Indication mode	LCD displays real-time data and system state, LED, sound, vibration indication alarm
Storage Conditions	Temperature: -10~55°C; Humidity: <85%RH
Operation Conditions	Temperature: - 20~50°C; Humidity: <95%RH non-condensing
Working voltage	DC 3.7V (Lithium battery capacity 1800mAh)
Battery Model	LP103450-1800mAh
Charging time	6~8h
Standby time	More than 8h on end (slightly change with working state)
Dimensions	71*153*49mm
Weight	215.4g(with battery and back button)

## 11. Charging function description

When the power is insufficient or the voltage cannot be turned on due to undervoltage, please charge in time and charge it. During the charging process, the alarm light will flash and the meter will no longer detect the gas concentration and display it dynamically. Indicates the number of battery packs. When the number of battery packs is full and no longer changes dynamically, charging is completed. When you can unplug the charger, the meter can be used normally.

## 12. Warnings and Precautions

Improper operation or environment may cause accidents.

1. The instrument is strictly prohibited from collision, falling from high places or violent vibration.
2. If there is gas of high concentration, the instrument may not work properly.
3. Please operate and use strictly in accordance with the instructions, otherwise it may result in inaccurate test results or damage to the instrument.
4. Do not store the instrument in the following environments:
  - a. Places that may have water or heavy dust.
  - b. The instrument must not be stored and used in environments that contain corrosive gases (such as salt or sulfur in high concentration, etc.).
  - c. Air with other gases or chemicals.
  - d. Places of high temperature, high humidity or direct sunlight, including environments of too high and low temperatures, high humidity, electromagnetic fields, and strong sunlight.

5. Cleaning of the instrument's surface:
    - a. The window of the sensor must be kept clean. If it is dirty, the measurement will be inaccurate.
    - b. Please wipe it gently with a clean, soft cloth dampened with water (do not use alcohol, diluent, etc. to clean the case, especially for the LCD window.).
  6. In order to ensure accuracy, the instrument should be calibrated regularly, and the period can not exceed one year.
  7. If the instrument breaks down, please contact our professional personnel to repair it. Other people shall not change components and wiring.
-  Warning: prohibit charging or disassembling batteries in an explosive environment!

## 13. Product accessories list

Thanks for your purchasing our product, please check the following components after you unpacking the box. If there is any missing or wrong page manual, please contact the local dealer.

Accessory name	Quantity
Hydrogen Sulfide Monitor (Contain Alligator clips)	1PCS
Cover	1PCS
With screws	1PCS
Transparent trachea	1PCS
Charger	1PCS
Data line	1PCS
Manual	1PCS
Packing box	1PCS

**TIPS:** This device is equipped with rechargeable battery. If you receive the product and cannot start up, please connect with the adapter for charging before use.

### Special Statement:

Our company shall hold no any responsibility resulting from using output from this product as an direct or indirect evidence. this company reserves the right of changing the product design and contents of instruction if changed the separate, notice isn't given.