

Aquarium WiFi Monitor

User manual



Please read the instruction manual carefully before use

Catalog

- Product model and function-----1
- Details and measuring range-----2
- Probe cap and secure-----3
- Probe size and scene-----4
- Display host fixation-----5
- WIFI networking-----6
- Key function and repairing between display and probe---8
- pH、EC solution calibration-----11
- Salinity, specific gravity button calibration-----14
- Frequently asked questions-----16
- After-sales service-----17

It is recommended that the probe into the water depth is half of the entire probe, the probe is placed in the slow water flow, avoid bubbles, and the sea tank probe is not placed in the egg bin.

Model and function

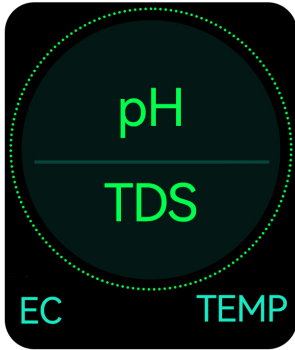

Four functions

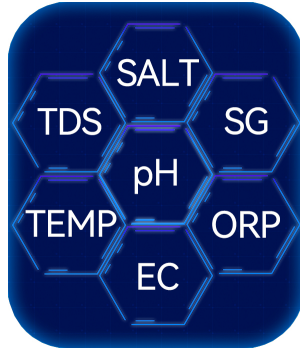

Seven functions

Four functions: ph, temperature, TDS, conductivity;

This model is commonly used in: freshwater fish tanks, hydroponics, fish ponds, swimming pools, etc.

Seven functions: ph, temperature, TDS, conductivity, salinity, specific gravity, ORP;

This model is usually used in: freshwater fish tank, seawater fish tank, hydroponics, fish tank, swimming pool and so on.

What should be noted is:

The small range unit of TDS is ppm, the large range unit is ppt, the unit is automatically switched, $1\text{ppt}=1000\text{ppm}$;

The small scale unit of EC(electrical conductivity) is $\mu\text{S}/\text{cm}$. The large range unit is mS/cm , the unit is automatically switched, $1\mu\text{S}/\text{cm}=1000\text{mS}/\text{cm}$;

The salinity unit is %, $1\%=10\%$, please do not use the TDS large scale unit ppt as the salinity unit.

Product Information

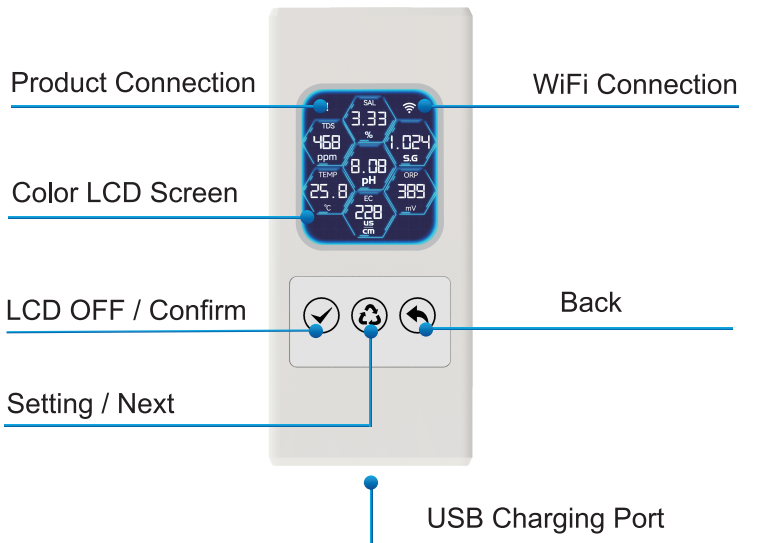

Measuring Range

Parameter	Range	Resolution	Accuracy
PH	0-14	0.01	0.05
Temperature	0-60°C 32-140°F	0.1 0.5	±0.1 ±0.1
Total Dissolved Solids	0-999ppm 1-20ppt	1ppm 1ppt	±5%F.S
Electrical Conductivity	0-999us/cm 1-400ms/cm	1us/cm 1ms/cm	±5%F.S
Salinity	0.01%-25%	0.01%-5%(±0.1%) 5.1%-25%(±0.1%)	±2%F.S
Specific Gravity	1-1.222	/	/
ORP	0-±999mv	1mv	/

Probe cap replacement and water level line

The probe will be protected by a sealed lid before leaving the factory, which contains the probe protection liquid, which is usually saturated potassium chloride, volatile and easy to crystallize, sometimes you will see the probe has something similar to salt, which is a normal phenomenon. When using, unscrew the protective cap of the probe counterclockwise, pour out the protective liquid, clean the probe, and install it. If it is not used for a long time in the later period, you can add half the tap water of the lid to screw on to moisten the probe. If there is more algae in the probe at a later stage, it can be cleaned by soaking it in sodium hypochlorite thinner for 6 hours, and please brush the probe. For daily use, it is recommended to calibrate pH every 4-6 months.

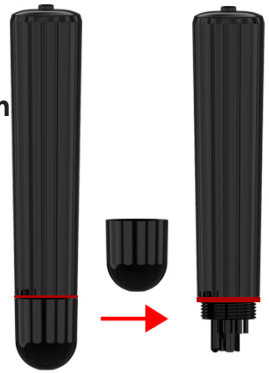

Probe fixation

There are two ways to fix the probe, one is a bracket, the other is a suction cup, **both ways are inserted from the bottom of the probe installation**, the specific can be selected according to the aquarium scene.

Here, it should be noted that although our probe is completely waterproof in design, that is, the whole probe can be put into the water but in the industry, whether it is industrial or civil, the working principle of pH is ion penetration, if the probe into the water is too deep, it will lead to too much water pressure on the probe, and the service life of the pH probe will be reduced for a long time. **We recommend putting the whole probe halfway into the water**, please pay more attention!

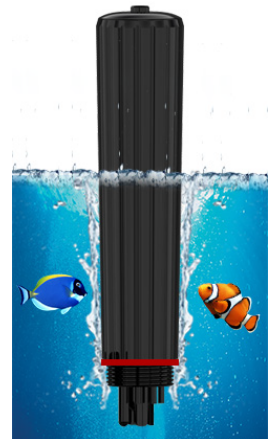

size and application scenarios

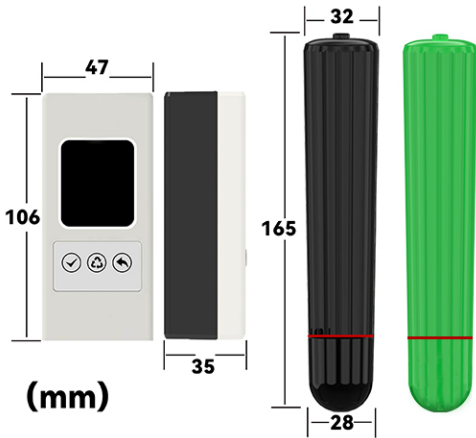

Hydroponic probes are green in appearance



It is recommended that the distance between the display host and the probe be kept within 5 meters without obstruction

Product Installation



1: Remove the sticky adhesive backing film



2: Glue the bracket to a smooth area



3: Attach the other part of the bracket to the back or side of the display



4: Secure the display by running it down the track to the bottom

WiFi Connection



Tuya Smart

1. Download the APP.

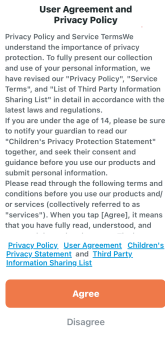

3. Agree with the terms.

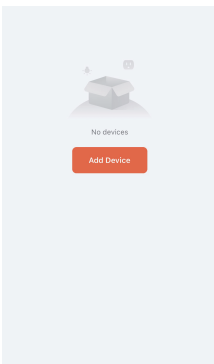

5. Click 'Add Device'.



2. Allow all the required access.

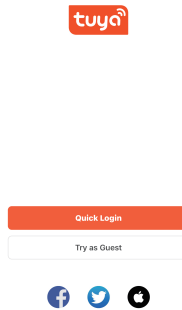

4. Log in or Register.

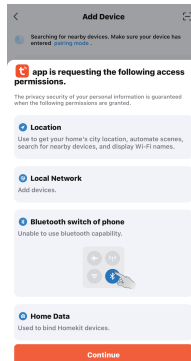

6. Click 'Continue'.

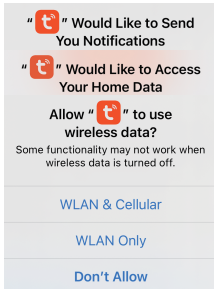

7. Allow all the required access.



9. Long press the middle button for 3 seconds and release it.

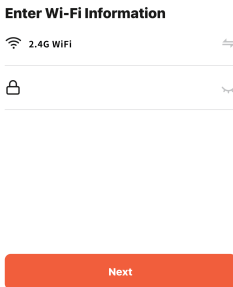

11. Connect it to your 2.4GHz WiFi, and click 'Next'.



8. Please power up the display.

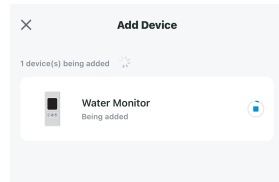

10. Click 'Water Monitor'.

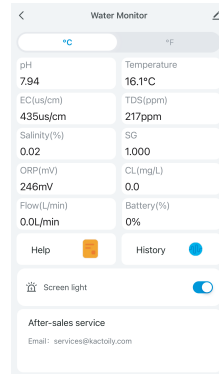

12. Connection completed!

Connection between Display & Probe

The display and probe are pre-connected at the factory and ready for use after calibration. If '!' continuously appears on the screen, it indicates a disconnection between the probe and the display.

***Please note that it's normal for "!" to briefly appear during regular use.**

The reasons for the '!' symbol appearing are as follows:

1. The distance between the display and the probe is too far. Please reduce the distance accordingly.
2. Restoring the product to factory settings clears the connection, so the display and probe will need to be reconnected.
3. The probe is not powered on.

To connect the display and probe, follow these steps:

1. Reset the monitor to factory settings, ensuring the power remains on during the reset process.
2. Turn off the probe, then power it back on to complete the connection.

Basic Operation

LCD OFF

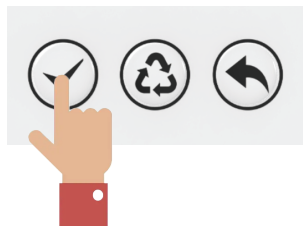

Press and hold  for 3 seconds to turn off the screen light. A short press on any of the three buttons will turn the display back on.

***Turning off the screen will not affect data collection or analysis.**

Configure WiFi



Press and hold  for 3 seconds, then release. The display will beep 3 times, indicating that it's connecting to the network.

Remove the Monitor Connection from the APP



Press and hold  for 3 seconds, then release. The monitor connection will be automatically deleted, allowing you to connect it to another mobile phone.

**This method will not delete historical data records.*

Switching Temperature Units

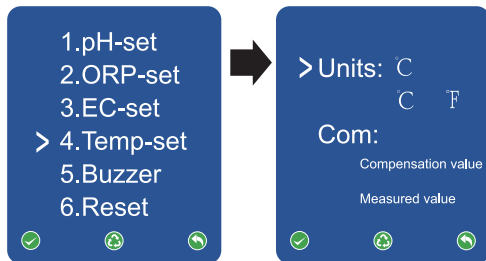

1. Enter the settings menu by pressing the middle button.
2. Select 'Temp-set', by pressing the middle button again, and confirm your choice with the left button.
3. Use the left button to choose between Fahrenheit and Celsius.

Factory Reset

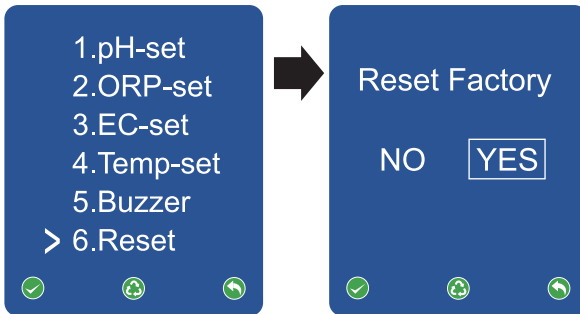

1. Press the middle button to enter the settings menu.
2. Click the middle button to select 'Reset', and choose 'YES'.

Note: You can restore the device to its factory settings if you need to replace the probe or if the data display is abnormal. This will delete the data and require you to reconnect the display and the probe. Please perform this operation with caution.

Calibration and Adjustment

Before Calibration

1. Prepare three 250 ml glasses of purified water. Do not use mineral or tap water.
2. Completely dissolve the pH 4.0, 6.86, and 9.18 calibration powders in the three glasses of purified water.
3. Remove the protective cover from the probe.

pH Calibration

Two-point calibration is performed the same way as three-point calibration, except one less step is required. We recommend three-point calibration for greater accuracy.

3-point calibration for pH

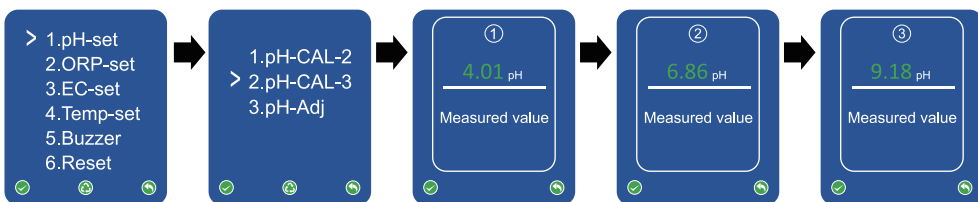

1. Press the middle button to enter the settings menu.
2. Press the left button to select the option, 'pH-set'.
3. Press the middle button to move to the option, 'pH-CAL-3'. Then press the left button to confirm, and the device will enter the pH 4.01 calibration screen.
4. Place the probe in the pH 4.01 calibration solution. The displayed value shows the current measurement.
5. Gently shake the probe to ensure full contact with the solution. Wait for the reading to stabilize, then press the left button to confirm.
6. After it switches to the pH 6.86 calibration screen, clean the probe in neutral or purified water, and wipe off any remaining liquid.
7. Place the probe in the pH 6.86 calibration solution. Shake it gently, wait for the reading to stabilize, then press the left button to confirm.
8. When the pH 9.18 calibration screen appears, clean the probe again, wiping off any remaining liquid.
9. Place the probe in the pH 9.18 calibration solution. Shake it gently, wait for the reading to stabilize, then press the left button to confirm.
10. Clean the probe thoroughly as before.

pH Adjustment

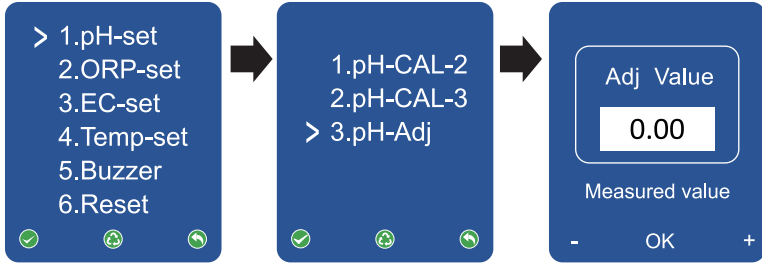

Feel free to adjust the measurement directly on the monitor if you need.

1. Press the middle button to enter the settings menu, then press the left button to select the option, 'pH-set'.
2. Press the middle button to navigate to 'pH-Adj', and then press the left button to confirm.
3. The monitor will enter the pH adjustment interface, with the default compensation value set to 0.
4. Use the left or right buttons to decrease or increase the value ('- / +'), then press the middle button to save your adjustment.

*The displayed value reflects the testing result.

EC Calibration



Conductivity calibration fluids are usually more expensive, and Marine tank customers (salinity and specific gravity) recommend direct keystroke adjustment.

1. Press the middle button to enter the settings menu, then press it again to navigate to the option, 'EC-set.'
2. Press the middle button again to select 'EC-CAL', then press the left button to confirm. The device will enter the 1413 $\mu\text{S}/\text{cm}$ calibration screen.
3. Place the probe in the 1413 $\mu\text{S}/\text{cm}$ calibration solution. The displayed value reflects the current measurement.
4. Gently shake the probe to ensure full contact with the solution. Wait for the reading to stabilize, then press the left button to confirm.
5. Once it switches to the 12.88 mS/cm calibration screen, clean the probe with neutral or purified water, and wipe off any remaining liquid.
6. Place the probe in the 12.88 mS/cm calibration solution, shake it gently, and wait for the reading to stabilize. Press the left button to confirm.
7. When the 111.3 mS/cm calibration screen appears, clean the probe as before, and wipe off any remaining liquid.
8. Place the probe in the 111.3 mS/cm calibration solution, shake it gently, and wait for the reading to stabilize. Press the left button to confirm.
9. Clean the probe thoroughly as before.

EC Adjustment

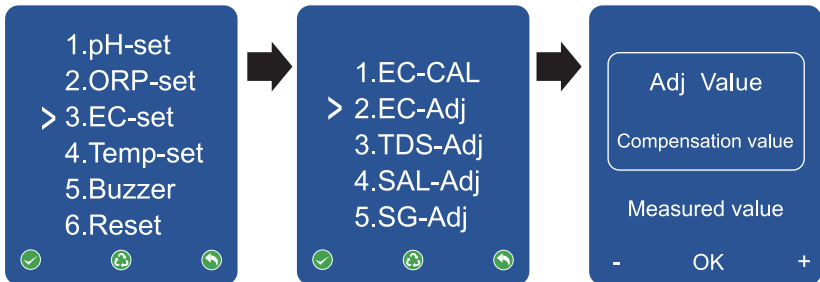

1. Press the middle button on the monitor to enter the settings menu.
2. Use the middle button to navigate to the option, 'EC-set', then press the left button to confirm.

3. Use the middle button to navigate to 'EC-Adj', then press the left button to confirm.
4. Use the left or right buttons to adjust the value ('- / +'), then press the middle button to save the setting.

TDS Calibration

TDS calibration is not performed separately. When you calibrate EC, TDS will be calibrated simultaneously.

Salinity Calibration

TDS calibration is not performed separately. When you calibrate EC, salinity will be calibrated simultaneously.

SG Calibration

TDS calibration is not performed separately. When you calibrate EC, SG will be calibrated simultaneously.

TDS Adjustment

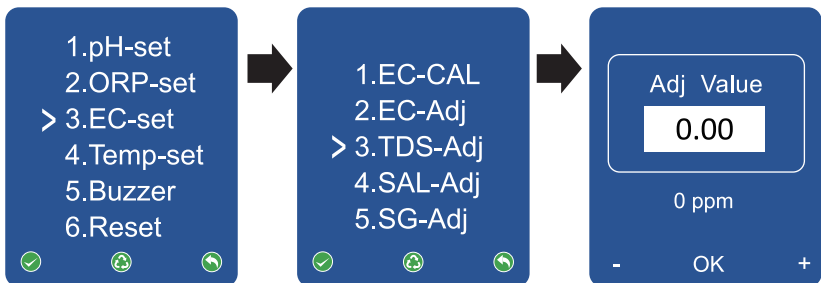

1. Press the middle button on the monitor to enter the settings menu.

2. Use the middle button to navigate to the option 'EC-set', and press the left button to confirm.
3. Use the middle button to navigate to the option 'TDS-Adj', and press the left button to confirm.
4. Use the left or right buttons to adjust the value ('- / +'), then press the middle button to save the setting.

Temperature Adjustment

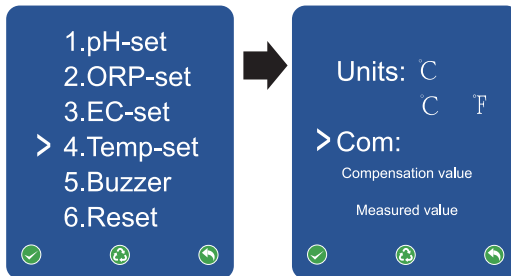

1. Enter the settings menu by pressing the middle button.
2. Access 'Temp-set', by pressing the middle button, and confirm your selection with the left button.
3. Press the middle button to select 'Com', then confirm with the left button.
4. Use the left or right button ('-/+') to adjust the setting, and press the middle button to save.

Verification of salinity and specific gravity

33g kcl (potassium chloride) +1000g pure water, the salinity of the configuration is about 3.2%, the specific gravity is about 1.022!
 If there is no kcl (potassium chloride) and pure water, directly use 33 grams of edible salt +1000 grams of tap water, the salinity configured is also about 3.2%, the specific gravity is about 1.022!
 All salinity measuring equipment can be verified in this way.
 If there is a difference, use it directly.

Why is it not recommended to use fish tank sea salt directly, because there are more kinds of this salt on the market, and the purity is not the same.

Frequently Asked Questions

Q: How deep should the probe be placed in water?

A: The probe should be placed at a depth where it is fully submerged between the highest and lowest water levels.

Q: Do I need to calibrate the pH monitor when I first receive it?

A: It is ready for use upon receipt. If the measurements show any discrepancies, please use the device after calibration or manual adjustment of the values.

Q: Does the monitor emit any current into the water during data collection and processing?

A: No, the monitor does not emit any current into the water during data collection, processing, or transmission. It uses high-frequency forward and reverse pulses that do not send an electric current into the water, so it will not affect the fish.

Q: What does it mean if the monitor displays a "!" symbol?

A: The "!" symbol indicates that the display and the probe have been disconnected. This usually means the display cannot receive data from the probe, likely due to too much distance between them. To fix this, shorten the distance between the display and the probe.

Q: Why does the pH value keep fluctuating and show a low reading?

A: Please check if the pH probe is cracked. The likelihood of probe damage increases significantly when the temperature is below 20°C / 68°F. In winter, avoid placing the probe outdoors or in environments with low temperatures.

After-sales Service

This product comes with a one-year warranty. During this period, if the product is damaged due to manufacturing defects, it will be repaired or replaced free of charge.

The warranty does not cover the following circumstances:

1. Damage caused by natural disasters or other unavoidable events.
2. Damage resulting from improper handling, use, maintenance, or storage, including consumer disassembly or repairs.
3. Corrosion of the circuit board or power supply connector caused by exposure to water.

***Note: The display is not waterproof. Please handle it with care to avoid water damage.**

If you have problems you can't resolve, you can add
WhatsApp: +86 173 3716 8389.