

DIGITAL MANOMETER

User Manual

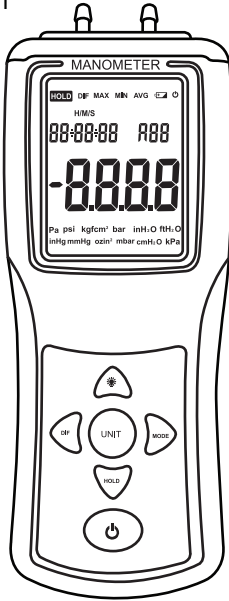

SCAN THE QR CODE

to download the
USER MANUAL
in different languages
and **SOFTWARE**



TUTORIAL VIDEO ON HOW TO USE

Need more help? CONTACT US.

www.cd50.net/dp-103

INTENDED USE

This instrument can measure the air pressure of the single pipe or the pressure difference between two detection ports. It offers 12 units of measurement and advanced features like DATA HOLD, MIN-MAX-AVG mode, ZERO, DATA RECORD, and AUTO POWER OFF. It is widely used in natural gas pipelines, air-conditioning refrigeration, and ventilation systems, mechanical hydraulics, plastic molding, biopharmaceutical molding, mining area pressure detection, gas, liquid, and production industrial equipment pressure detection.

Thank you for purchasing this digital manometer. We recommend that you read and follow the manual carefully before use.

Features:

- 12 selectable units of Measurement
- Pressure difference measurement
- Maximum / minimum / average data mode
- Data hold function
- Large LCD with backlight
- Data storage function with a time stamp
- Zero function
- Low battery alarm
- Automatic power off function
- Over range indicator: Hi, Lo
- USB for power supply

SPECIFICATIONS

Pressure Range	±2.000 Psi
Units of measure	Pa, psi, kgfcm ² , bar, inH ₂ O, ftH ₂ O, inHg, mmHg, ozin ² , mbar, cmH ₂ O, and kPa
Accuracy	±0.3% FSO (at 25°C)
Repeatability	±0.2% (Max±0.5%FSO)
Linearity/Hysteresis	±0.29% FSO
Data Storage	99 groups
Response Time	0.5s
Out of Range Indicator	Hi or Lo
Automatic power off conditions	No operation for 10 mins
Operating Conditions	0 to 50°C (32 to 122°F)
Storage Conditions	-10 to 60°C (14 to 140°F)
Power supply	1.5V x 3pcs AAA batteries
Dimension	165 X 70 X 33mm
Weight	150g (without batteries)

- 1 -

RANGE SPECIFICATIONS

Function	Range	Resolution
Pa	±9999	1
psi	±2.000	0.001
kgfcm ²	±0.140	0.001
bar	±0.137	0.001
inH ₂ O	±55.40	0.01
ftH ₂ O	±4.613	0.001
inHg	±4.070	0.001
mmHg	±103.4	0.1
ozin ²	±32.00	0.01
mbar	±137.8	0.1
cmH ₂ O	±140.6	0.1
kPa	±13.78	0.01

METER DESCRIPTION

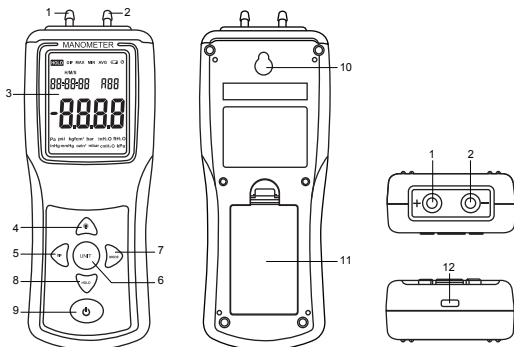

1. P1 Tube Connector (+)
2. P2 Tube Connector (-)
3. LCD Display
4. BACKLIGHT Button
5. DIF Button
6. UNIT Button
7. MODE Button
8. HOLD Button
9. Power on/off Button
10. Hanging Hole
11. Battery Cover
12. USB Socket (for power supply only)

- 2 -

DISPLAY

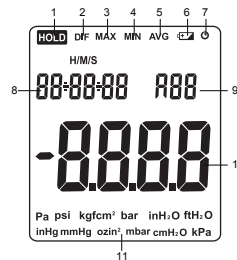

1. Data Hold Function
2. Differential Pressure Mode
3. Max Indicator
4. Min Indicator
5. Avg Indicator
6. Low Battery Indicator
7. Auto power off disable Indicator
8. Elapsed Timer
9. Total number of records
10. Reading Display
11. Pressure Units

KEY OPERATION

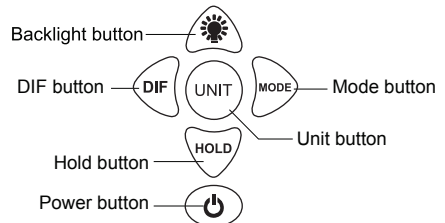

POWER ON/OFF BUTTON



- When the power is off, short press the button to turn the meter on.
- When the power is on,
 - a. Short press the button to disable and enable the automatic power off function.
 - b. Press and hold the button to turn off the meter.

In order to conserve battery life, the meter has an automatic power off function (without operation after 10 minutes). The auto power off disable indicator will appear on the display when the auto power off function is disabled. The meter will now remain on until the user turns it off or until the battery runs out.



Note that the Auto Power OFF function will be reactivated the next time the meter is turned off and then on.

- 3 -

BACKLIGHT BUTTON

- Short press the  button to store the current measured pressure value with a time stamp (can store up to 99 groups).
- Press and hold the  button to open/close the backlight.

HOLD BUTTON

- Short press the  button to freeze/release the displayed reading.
- Press and hold the  button to clear the stored data.





MODE BUTTON

- Short press the  button to enter the MAX, MIN, and AVG mode.



MAX MODE - When in this mode, only the highest (MAX) reading recorded since the  button was first pressed will appear on the reading display.

MIN MODE - When in this mode, only the lowest (MIN) reading recorded since the  button was first pressed will appear on the reading display.



AVG MODE - When in this mode, only the average (AVG) reading recorded since the  button was first pressed will appear on the reading display.

- Press and hold the  button to view the stored data, the no. indicator will appear on the right-hand corner of the LCD display, to indicate that it is in the data review mode. Press the  or  button to view the data one by one.
- Press and hold the  button again to exit the data review mode.

DIF BUTTON

- Short press the  button to enter P1 and P2 dual channel differential pressure mode. **DIF** icon will appear on the display.
- Short press the  button again to exit differential pressure mode.
- Press and hold the  button to clear the drift zero. (The data before measurement does not return to zero and without fittings attached to the meter).

UNIT BUTTON

- Short press the  button to select the desired measurement unit. This meter offers up to 12 pressure units.
- Press and hold the  button to enter the time setting mode.
- While on the time setting mode, short press on the  button to exit the time setting mode or save the setting.

OVER RANGE







H_i symbol will appear on the display when the pressure reading is over the Maximum range.

L_o symbol will appear on the display when the pressure reading is below the Minimum range.

BASIC OPERATION

- Short press the  button to turn on the meter and select the desired measurement unit by pressing the  button.



- The reading before measurement and without fittings attached to the meter should return to zero. If not, need to **ZERO** the meter by pressing and holding the  button for 3 seconds or until the display shows all zeros.

- Press and hold the  button to enter the time setting if needed. The current setting value will be blinking on the LCD, press the  or  button to increase or decrease the value. Once the current setting value is done, press the  or  button to move forward or backward to the next value setting. Short press the  button to save the setting when all are done.

- Connect the tubing to the P1, P2 (or both) input port(s). If both inputs are used (DIF mode), the meter displays a positive pressure reading if the P1 pressure is greater than P2 and a negative reading if P2 is greater than P1.



- Short press the  button to store the current measured pressure value with a time stamp (can store up to 99 groups).

Note that once the stored data reached the 99 groups, it will start to record from scratch (the first group R01) if you still press the  button to record. The previous records will be cleared up.

- Press and hold the  button to view the stored data, the no. indicator will appear on the right-hand corner of the LCD display, to indicate that it is in the data review mode. Press the  or  button to view the data one by one.

- To clear up the stored data, press and hold the  button for 3 seconds.

BATTERY REPLACEMENT

If the meter is not turning on even when the  button is pressed or if the display shows , replace the batteries with 3 pieces of AAA 1.5V battery.

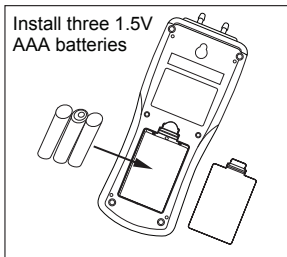

Dispose of the battery in an environmentally safe recycling point.

DO NOT DISPOSE IN YOUR BIN!

TROUBLE SHOOTING

- Power on but no display or the display disappears
 - Check the batteries if they are in place (in proper contact with the pins) and in correct polarity.
 - Remove battery for one minute and re-install.
 - Replace the batteries.
- For all other issues please contact your supplier.

CONVERSIONS

Useful conversion Factors

From	To	Multiplier
in of H ₂ O	in of Hg	0.07355
in of H ₂ O	cm of H ₂ O	2.54
mm of Hg	in of H ₂ O	0.03937